

Standard Preparation Cupboard with 2 Sliding Doors - no top, 1200mm

ITEM # _____

MODEL # _____

NAME # _____

SIS # _____

AIA # _____

133181 (RAU1200SD)

Cupboard with 2 sliding doors - no Top, 1200mm

Short Form Specification

Item No. _____

Made entirely from stainless steel. Inner welded frame in stainless steel. No top unit for integrated solutions. Sound-deadened sliding doors. Base panel in 304 AISI stainless steel and heightadjustable intermediate shelf. Mounted on feet, adjustable in height.

Main Features

- Ideal for central positioning in the kitchen, either as island installation or back to back.
- Handles in stainless steel for better hygiene and reliability.
- Sturdiness, stability and reliability of table accurately tested.

Construction

- Reinforced side and base panel in 304 AISI stainless steel.
- 304 AISI stainless steel feet, 200 mm high and 54 mm in diameter, adjustable by -50/+30 mm.
- Inner welded frame in stainless steel to guarantee superior strength and stability.
- Equipped with intermediate shelf which can be positioned at three different heights.
- Sturdy sound-deadened sliding doors on tracks located flush to the front of the frame.
- Without top for integrated solutions.

Optional Accessories

- Stainless steel front kicking strip PNC 133205
- Side kicking strip, 700 mm PNC 133206

APPROVAL: _____

Front

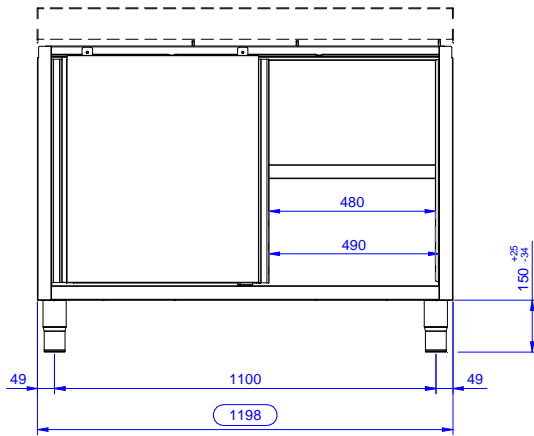

Side

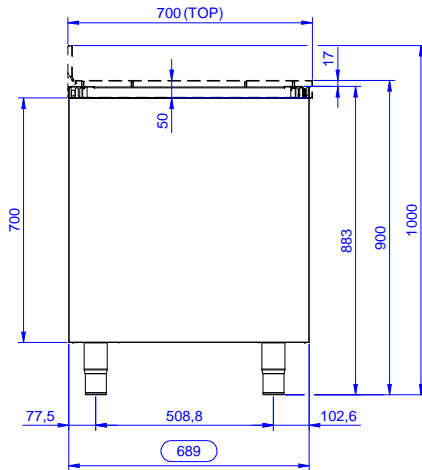

Top

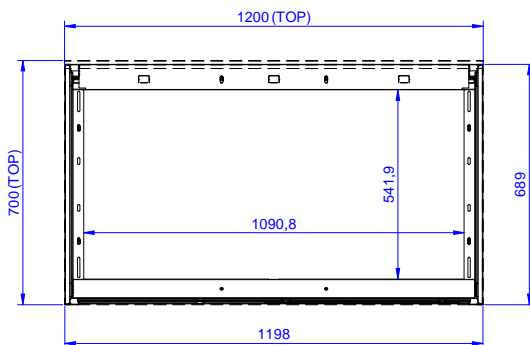

Key Information:

Cabinet width:	
133181 (RAU1200SD)	1145 mm
Cabinet depth:	645 mm
Cabinet height:	610 mm
External dimensions, Width:	1189 mm
External dimensions, Depth:	700 mm
External dimensions, Height:	883 mm
Number and type of doors:	2 Sliding
Net weight:	40 kg